



Shandong Chufeng Heavy Industry Machinery Group Co., Ltd

## Tracked Scissor Lift

# Operation and Maintenance Manual



### Warning

The relevant regulations and requirements in the instruction manual must be read carefully before operating the machine. Any violation thereof, operator shall be liable for all consequences therefrom



Shandong Chufeng Heavy Industry Machinery Group Co., Ltd

**Shandong Chufeng Heavy Industry Machinery Group Co., Ltd**



Shandong Chufeng Heavy Industry Machinery Group Co., Ltd

-Operation and Maintenance Manual

## Contents

I. Operation Manual .....	1
1. Overview .....	1
2. Main Components of Product .....	2
3. Operation Procedures of Tracked scissor lift .....	3
4. Safety rules for lifting operation .....	10
I. Maintenance Manual .....	17
1. Battery and charging instructions .....	17
2. Maintain safety rules .....	18
3. Common fault analysis and processing .....	20
4. Working principle.....	23
Drawing of Hydraulic principle: .....	23
Drawing of electrical principle: .....	24
II. Part List of Self-Propelled Scissor Lift.....	26

**Shandong Chufeng Heavy Industry Machinery Group Co., Ltd**

Add: No.1 Hui River Industry Park, Jiyang, Jinan, Shandong,China

Website:www.cfmglift.com

Email:sales@cfmglift.com



Shandong Chufeng Heavy Industry Machinery Group Co., Ltd

**-Operation and Maintenance Manual**

# I. Operation Manual

## 1. Overview

The tracked scissor lift, which is developed by CFMG, is featured of easy movement, simple operation, wide application, ideal for goods and people lifting. The tracked scissor lift adopts scissor type lifting structure, which is made of high-quality rectangular manganese steel tube, with merits of high overall strength, large load capacity and good lifting stability. The strong, and low-consumption servo motor is used to provide the driving power, which is highly praised by users.

### **Application:**

1. Aerial installation and maintenance work;
2. Municipal, outdoor advertising operations;
3. Urban construction, oilfield operations;
4. Excellent for rough terrain conditions, such as desert, sandstone, mud, etc.



Tracked Scissor Lift

## 2. Main Components of Product

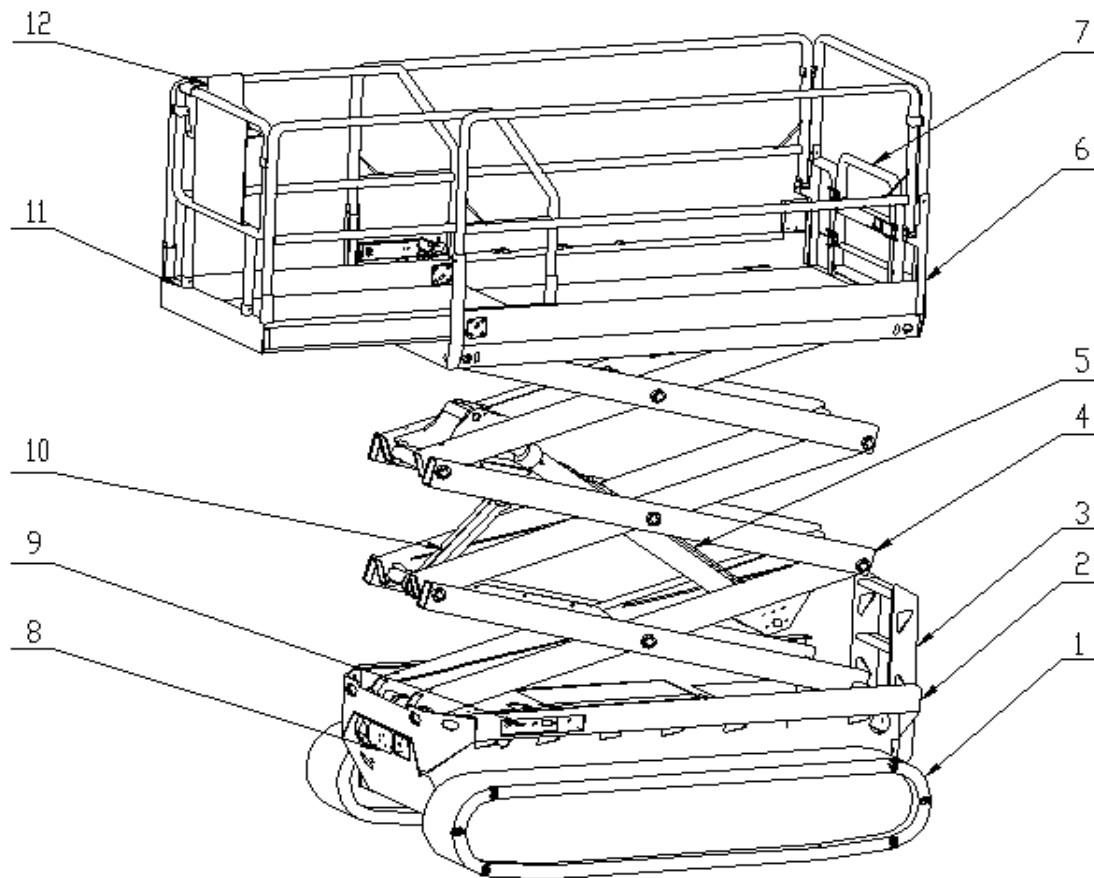

1. Crawler    2. Chassis    3. Ladder    4. Scissors    5. Lifting Oil Cylinder    6. Platform    7. Platform Door  
 8. Hydraulic and Electric Control Box    9. Ground Control Panel    10. Maintenance Support    11.  
 Extendible Platform    12. Joystick



Shandong Chufeng Heavy Industry Machinery Group Co., Ltd

-Operation and Maintenance Manual

### 3. Operation Procedures of Tracked scissor lift

#### Basic Principles:

1. Performing pre-operational inspection and routine maintenance is the responsibility of the operator. Pre-operational inspection is a very intuitive inspection process that should be performed by the operator before each shift. Purpose of the inspection is to find out if there is an obvious problem with the machine before the operator performs functional test.
2. Pre-operational check can also be served to determine if a routine maintenance procedure is required. The operator can only perform the routine maintenance items specified in this manual.

#### Precautions:

- ◆ Ensure that the operator does not experience dizziness and other high phenomena at high altitudes.
- ◆ Ensure that no other persons are involved in the equipment before operation

#### Pre-operation check

- Make sure the manual is complete, legible, and well kept.
- Make sure all labels are clear, legible and in the right place. See the "Post Labels" section.
- Check if the hydraulic oil leaks and the oil level is appropriate and refuel it as needed. See the "Maintenance" section.
- Check if the battery fluid leaks and the liquid level is appropriate. Add distilled water as needed. See the "Maintenance" section. Inspect the following parts or areas for damage, improper installation, or missing parts and unauthorized changes:
  - Electrical components, wiring and cables
  - Hydraulic hoses, fittings, hydraulic cylinders and hydraulic valve blocks



Shandong Chufeng Heavy Industry Machinery Group Co., Ltd

**-Operation and Maintenance Manual**

- Batteries and their wiring
- Drive motor
- Wear-resistant sliders and pads
- Crawlers and wheels
- Ground wire
- Limit switch, alarm and horn
- Nuts, bolts and other fasteners
- Platform overload parts
- Platform entrance door
- Indicators and sirens (if any)
- Safe arm
- Extendible platform
- Scissor arm pins and fasteners
- Joystick
- Pothole protection device

**Note:** If the platform must be raised to check the machine, make sure the safety arm is in the correct position.

**Step 1: Check the Lift**





1. Check if the square tube is broken



2. Check if there is oil leakage or circuit damage in the electrical system.

## Step 2: Turn on the Main Power Switch

- ◆ Find the Main Power Switch



1. Turn on the red switch and pull it out

- ◆ Find the Ground Power Switch



2. Hold the red switch and turn it clockwise about half a turn. The switch pops up to open the switch.

◆ Find the Platform Power Switch



1. Find the red button at the joystick

◆ Turn on the Red Switch



2. Hold the red switch and turn it clockwise about half a turn. The switch pops up to open the lower switch.

### Step 3: Select Operation Position

- ◆ Find the key switch next to the red ground switch



Turn left the key for selecting platform operation

Turn right the key for selecting ground operation

- ◆ Select Ground Operation



When the key hits the ground position (as shown), lift up the right button for lifting the equipment; and press down the button for lowering the lift

◆ Select Platform Operation



When the key hits the platform position (as shown), the operator can climb to the platform for operation.

### Step 4: Platform Control

- ◆ Use the joystick for operation



- ◆ Walking:

1. Press button **B** to perform the walking function.
2. Hold the handle (Position **3**), press the position **2** at the handle, push the handle forward to go ahead, pull it back to go back, press position **1** to turn.

- ◆ Up and Down:

1. Press button **A** for going up and down.
2. Hold the handle ( Position **3**), press the button **2** at the handle, push the handle forward for going up, and pull it back for going down.

- ◆ Horn:

1. Press 5, the horn sounds to remind the surrounding people to pay attention to safety.

- ◆ Turtle speed:

1. Press **4** , the vehicle speed is reduced.

### Emergency processing function

- ◆ Manual lowering (for vehicle down fault)



Pull the plug in the picture to release the device manually (pull it by hand), the platform is lowered

### Step 5: Turn off Main Power

1. Turn off the ground power



After use, turn the key switch to the vertical position and pull it out. Press the red switch at the bottom to turn off the power (Turn off the power supply is ok)



## 2. Turn off the Main Power



Turn off the main power as shown

## 4. Safety rules for lifting operation

### 4.1 Notes

- The work vehicle must not be lifting operation, when it is not placed on a level, sturdy ground.
- It is strictly forbidden to work on unstable ground, especially on the ground with holes and unstable surface.



Shandong Chufeng Heavy Industry Machinery Group Co., Ltd

**-Operation and Maintenance Manual**

- When the work platform is overhauled, it must be shut down for maintenance.
- It is strictly forbidden to use the work platform as a welding ground wire.
- Lifting work is strictly prohibited when the wind force of the work site is greater than 6 or above.
- It is strictly forbidden to work in thunderstorms and storms.
- It is strictly forbidden to sit, stand or climb the edge of the work bucket.
- Overloading is strictly prohibited.
- It is strictly forbidden to hang various items outside the work bucket.
- It is strictly forbidden to make any modifications to the equipment that affect stability
- This machine is not insulated and does not provide electrical shock protection when in contact with or near electrical wiring.
- It is strictly forbidden to have obstacles under the working arm and under the bucket during operation to avoid danger.



**4.2 Danger of Tipping**

**The personnel, equipment and materials on the platform shall not exceed the maximum capacity of the platform and the extension platform.**

<b>Maximum load capacity--GTJZ0608LD</b>			
Max. number of people (indoor)	<b>2people</b>	Max. number of people (outdoor)	<b>2people</b>
Max. working load of the platform	<b>450kg</b>	Max. working load of the extended platform	<b>113 kg</b>

Platform retraction

Platform extension



Platform only

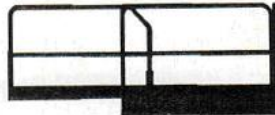

Extend platform only

### 4.3 Safety rules

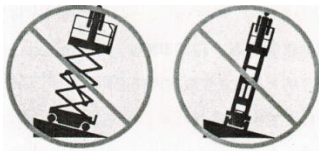

1. Lift the platform only on a solid, flat level ground.
2. The tilt alarm cannot be used as a level indicator. The tilting alarms on the chassis and platform will only sound when the machine is heavily tilted.
3. If the tilt alarm sounds:  
Lower the platform. Move the machine to a solid level of ground. If the tilting alarm sounds when lifting the platform, be careful to lower the platform.
4. For outdoor use, the platform cannot be raised when the wind speed may be greater than 12.5 m/s. If the wind speed exceeds 12.5 m/s after the rise, the platform should be lowered immediately and the machine cannot be operated.
5. Do not operate the machine during strong winds or gusts. It is not possible to increase the surface area of the platform or load. Increasing the area exposed to the wind will reduce the stability of the machine.
6. Do not use the platform controller to release the platform when the platform is caught, jammed, or other nearby objects are blocking its normal movement. All personnel must leave the platform before intending to use the ground controller to release the platform.
7. In the closed state, the machine should be very careful and reduce the speed when driving on uneven terrain, gravel, unstable or smooth surface, near the hole and steep slope.
8. Can not push and pull any object outside the platform
9. Do not put your hands and arms close to areas where there is a risk of being cut or crushed.



Shandong Chufeng Heavy Industry Machinery Group Co., Ltd

**-Operation and Maintenance Manual**

10 When folding the railing, do not put your hand in a place where it may be pinched. Always grasp the guardrail when removing the guardrail locking pin to prevent the platform guardrail from falling down.

11. When using the controller to operate the machine on the ground, keep normal judgment and plan. Maintain a safe distance between the operator, the machine and the stationary object.

**⚠ Danger of operating on slopes**

Do not drive the machine on slopes that exceed the machine ramp and side slope rating. The ramp rating applies to the machine in the collapsed state.

Model	Collapse status	
	Maximum slope rating	Maximum side slope rating
GTJZ0608LD	<b>25%(14°)</b>	<b>25%(14°)</b>

Note: The slope rating is limited by ground conditions and traction.

**⚠ Falling danger**

1. During operation, the personnel on the platform must wear full body safety devices and secure them to the approved rope attachment points with safety belt hooks. Only one hook can be tied to each rope fixing point.
2. Do not climb or sit on the guardrail of the platform. Stand on the platform floor at all times.

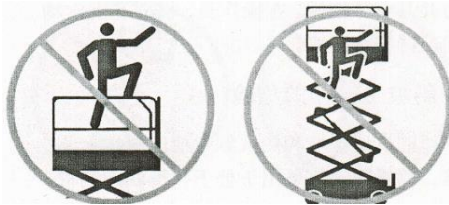

3. When the platform is lifted, it cannot climb down from the platform.
4. Keep the platform floor free of debris.
5. Close the entrance door before operation.
6. Do not operate the machine if the fence is not installed correctly or the entrance door does not guarantee safe operation.
7. Do not enter or exit the platform unless the machine is in a closed state.

**⚠ Collision risk**

1. When starting or operating the machine, attention should be paid to the sight range and the existence of blind spots.
2. When moving the machine, please pay attention to the position of the extended platform.

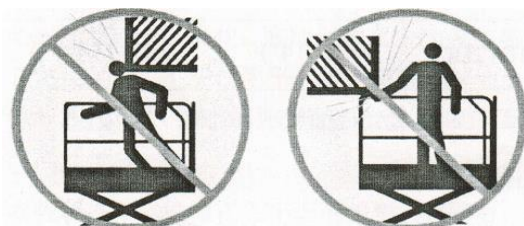



Shandong Chufeng Heavy Industry Machinery Group Co., Ltd

**-Operation and Maintenance Manual**

3. Check the work area to avoid obstacles or other possible dangers on the top of the head.
4. When grasping the platform fence, be careful of the danger of extrusion.
5. Users must abide by the rules governing the use of habeas corpus equipment in employers, workplaces and government laws and regulations.
6. The driving and steering arrows on the platform controller and the platform label should be observed and used.
7. Machines should not be operated on any crane or mobile elevated machinery route unless the crane controller is locked and/or precautions against any potential collision have been taken.
8. When operating the machine, do not drive dangerously or play with it.
9. Only when there are no people and obstacles in the area below the platform, can the platform be lowered.

**⚠ Risk of Machine Damage**

1. Do not use damaged or malfunctioning machines.
2. Before each change of work, the machine should be thoroughly checked before operation, and all functions should be tested. The damaged or malfunctioning machine should be marked immediately and stopped operation.
3. Ensure that all maintenance operations have been carried out in accordance with the provisions of this manual.
4. Ensure that all label positions are appropriate and easy to identify.

**Lock it after use.**

1. Choose a safe parking location, which can be a solid horizontal ground, free of obstacles and avoid busy transportation.
2. Make the platform down.
3. Turn the key switch to the "off" position and unplug the key to avoid unauthorized use.
4. Charge the battery.

## 5. Ways to Fold Guardrail

The platform guardrail system consists of a folding guardrail part of an extended platform and a folding guardrail part of a main platform. All parts are fixed in proper position by four steel wire lock pins.

1. Make the platform down completely and indent the extended platform.
2. Remove the platform controller.
3. Remove the two steel wire locks the front of the extending platform from the inside of the platform.
4. The front guardrail of the extended platform is folded inward. Do not place your hands where they may be pinched.
5. Install the two dismantled pins back to the guardrail brackets on each side.
6. Turn inward the extend platform guardrail on the right. Do not place your hands where they may be pinched.
7. Turn inward the extend platform guardrail on the left. Do not place your hand where it may be pinched.
8. Open the door carefully and move to a ladder or floor.
9. Remove the steel wire lock pin at the back of the right guardrail of the main platform.
10. Fold the right guardrail of the main platform from the ladder or on the ground. Do not place your hands where they may be pinched.
11. Install the detached pin back to the guardrail bracket.
12. Remove the steel wire lock pin at the rear of the left guardrail of the main platform.
13. Fold the left guardrail of the main platform. Do not place your hands where they may be pinched.
14. Install the detached pins back into the guardrail bracket.
15. Turn the back guardrail forward. Don't put your hand where it might be pinched.



Shandong Chufeng Heavy Industry Machinery Group Co., Ltd

**-Operation and Maintenance Manual**

### **How to Lift the Guardrail?**

Following Instructions of Fold the guardrail, but in reverse order.

### **How to Extend and stow platform?**

1. Put the foot on the positioning pedal which is on the extended platform.
2. Promote the extension of platform guardrail and extend the platform to the desired position.

Note: When trying to extend the platform, do not stand on the extended platform.



## 6. Specifications

CFMG 嘉峰集团	GTJZ0608LD	GTJZ0810LD	GTJZ1012LD
Safe working load	450Kg	450Kg	320Kg
Safety Work Load of Extended Platform	113Kg	113Kg	113Kg
Maximum number of workers	3	3	3
Maximum working height	8m	10m	12m
Maximum platform height	6m	8m	10m
Length of equipment ( with ladder )	2470mm	2470mm	2470mm
Length of equipment ( without ladder )	2350mm	2350mm	2350mm
Width of equipment	1450mm	1450mm	1450mm
Height of equipment ( Guardrail not folded )	2275mm	2400mm	2525mm
Height of equipment ( Guardrail folding )	1765mm	1890mm	2015mm
Working platform size	2270X1120mm	2270X1120mm X700mm	2270X1120mm X700mm
Platform extension size	900mm	900mm	900mm
Minimum turning radius	0m	0m	0m
Lifting motor	48V/2.2Kw	48V/2.2Kw	48V/2.2Kw
Walking motor	2X48v/4Kw	2X48v/4Kw	2X48v/4Kw
Machine running speed(closing)	2Km/h	2Km/h	2Km/h
Machine running speed(lifting)	0.5Km/h	0.5Km/h	0.5Km/h
Rate of rise/fall	24/34sec	28/38sec	38/46sec
Battery	8X6V/225Ah	8X6V/225Ah	8X6V/225Ah
Charger	48V/25A	48V/25A	48V/25A
Maximum climbing ability	30%	30%	30%
Maximum permissible working Angle	1.5° /3°	1.5° /3°	1.5° /3°
Machine weight	2750Kg	2870Kg	3030Kg



Shandong Chufeng Heavy Industry Machinery Group Co., Ltd

**-Operation and Maintenance Manual**

# I. Maintenance Manual

## 1. Battery and charging instructions

Obey the rules:

1. Do not use an external charger or booster battery.
2. Charge the battery in a well ventilated area.
3. Using the correct AC input voltage indicated on the charger.
4. Use only batteries and chargers approved by our company-CFMG Group

### Charging the battery

1. Make sure the battery is connected well before charging.

### Maintenance free battery

2. Connect the battery charger to a grounded AC circuit.
3. The charger will give an indication when the battery is fully charged.

### Standard battery

4. Remove the battery vent cover and check the battery electrolyte level. If necessary, add only enough distilled water that has not over through the plates. Do not add excess.



Shandong Chufeng Heavy Industry Machinery Group Co., Ltd

**-Operation and Maintenance Manual**

5. Replace the battery vent cover.

6. Connect the battery charger to a grounded AC circuit.

7. The charger will give an indication when the battery is fully charged.

8. Check the battery electrolyte level at the end of the charge cycle. Add distilled water to the bottom of the dosing tube. Do not add too much.

**Dry battery filling and charging instructions**

1. Remove the plastic venting cover from the battery vent and remove the plastic seal.

2. The battery electrolyte (electrolyte) is filled into each battery until the liquid level can overflow through the electrode plate.

Do not raise to the highest level before the battery charging process is complete. Excessive addition of liquid can cause the battery electrolyte to overflow during charging, Soda and water are used to neutralize the overflowing battery acid.

3. Install the battery vent cover.

4. Charge the battery.

5. Check the battery electrolyte level at the end of the charge cycle. Add distilled water to the bottom of the dosing tube. Do not add too much.



## Compliance and obedience:

When using a crane to lift the machine, maintain proper judgment and planning to control the movement of the machine. Only the personnel who are qualified for high-altitude lifting operation can load and unload the machine. Transport vehicles must be parked on level ground. When loading the machine, the transport vehicle must be fixed to prevent movement. Ensure the vehicle capacity, loading surface, chain or belt is sufficient to support the weight of the machine. Please refer to the nameplate for machine weight. Before releasing the brake, the machine must be on a horizontal surface or be fixed. Remove the bolt to prevent the guardrail from falling. Fold guardrail when want to hold guardrail tightly all the time. Do not drive the machine on slopes exceeding the upper, lower or slope ratings of the machine. refer to "driving on slopes" in the "instructions" section. If the vehicle's slope exceeds the maximum slope rating, the winch must be used to load and unload the machine as described in the brake release operation.

## 2. Maintain safety rules

- 1) The equipment shall be operated and maintained by trained personnel.
- 2) In the process of using the equipment, if the meter shows that the power is insufficient, please charge it in time. The charging time is 8-10 hours. When the equipment is not used for a long time, it is necessary to ensure charging once a month, so as to protect the battery and extend its service life.
- 3) The hydraulic oil is changed every six months. Use 32 # antiwear hydraulic oil in winter and 46 # antiwear hydraulic oil in summer.
- 4) When the equipment is not in use, it should be properly stored, dust cover should be added, and outdoor storage is strictly prohibited.
- 5) Check and maintain the platform once a month or once a year according to the frequency of use of the platform.



Shandong Chufeng Heavy Industry Machinery Group Co., Ltd

**-Operation and Maintenance Manual**

- [1] check whether the pin shaft nut at each link of the platform is loose or detached
- [2] check whether the hydraulic pipeline is broken and whether the joints are leaking or loose
- [3] check whether the hydraulic pipeline is not connected well and bare
- [4] check whether the connectors of the electrical box are loose and whether the indicator light works normally
- [5] check whether the control handles and buttons of electrical and hydraulic valve blocks are flexible
- [6] check whether the upper and lower limit switches on the platform are loose or damaged
- [7] check the lubrication condition of platform support pin shaft and cylinder pin, and inject enough lubricating oil
- [8] keep the sliding way on the platform and the platform in a lubricating state, and the sliding way shall not be short of lubricating oil

### 3. Common fault analysis and processing

LED CODE		Description	Troubleshooting
Green light out		No power or not working	<ol style="list-style-type: none"> <li>1. It is necessary to check if the wiring is correct when there is no power.</li> <li>2. Check the fuse and power switch.</li> </ol>
Green light is always on		Normal operation	
Red and green lights are on at the same time			<ol style="list-style-type: none"> <li>1. Software updating.</li> <li>2. Overvoltage or undervoltage reset</li> <li>3. The controller is damaged, please contact us.</li> </ol>
The red light is darker, but it is always bright			<ol style="list-style-type: none"> <li>1. Output 5V short circuit.</li> <li>2. Check the connection</li> </ol>
<b>RED LED ERROR CODE</b>			
1, 2		Overvoltage error	<ol style="list-style-type: none"> <li>1. The battery voltage is higher than the maximum operating voltage of the controller. Please check the battery voltage.</li> <li>2. The battery voltage is too high during power generation. The controller will stop generating electricity.</li> </ol> <p>The controller may detect an overvoltage with a 2% error.</p>
1, 3		Low voltage error	<ol style="list-style-type: none"> <li>1. If the voltage returns to normal after 5 seconds, the controller will attempt to automatically clear the fault code.</li> <li>2. Check the battery voltage.</li> </ol> <p>Charge the battery if necessary.</p>



Shandong Chufeng Heavy Industry Machinery Group Co., Ltd

-Operation and Maintenance Manual

1, 4	☒ ☒☒ ☒☒	Temperature warning	The temperature of the controller housing is above 90 ° C. At this point the controller will weaken the output current. It is recommended to stop the output or reduce the output to lower the temperature to protect the controller.
2, 1	☒ ☒ ☒	The motor can not be started	Two seconds after the controller starts outputting, the motor speed does not reach 25 electrical RPM, which is probably a problem with Hall or phase line.
2, 2	☒ ☒ ☒☒	Internal voltage error	<p>1. Please check that the battery voltage and control voltage are correct, Maybe the control voltage is too low.</p> <p>2. Check the load of 5V voltage, maybe the load of 5V voltage is too high, the load voltage is so high maybe because of the incorrect external device wiring.</p> <p>3. The controller is damaged, please contact us. .</p>
2, 3	☒☒ ☒ ☒☒	Over temperature error	<p>1. At this time, the temperature of the controller case exceeds 100 ° C, and the controller stops output to protect the controller.</p> <p>2. At this point, the controller needs to be turned off to lower the temperature. When the temperature of the controller is lower than 80 ° C, the controller will continue to work.</p>
2, 4	☒☒  ☒☒☒☒	Pedal error at startup	<p>1. The controller is turned on, and the error occurs when the accelerator pedal is in the active area (the default 20%-80% interval is valid. For example: 0-5K pedal is actually 1K starting as 1%, 4K is regarded as 100%), Resetting the pedal effective range through the configuration program.</p> <p>If the pedal is turned on, the power-off failure will disappear after the accelerator pedal released.</p>



Shandong Chufeng Heavy Industry Machinery Group Co., Ltd

-Operation and Maintenance Manual

3, 1	☒ ☒ ☒ ☒	The controller performs multiple resets	<p>1. Controller overcurrent protection.</p> <p>2. May be caused by problems such as motor failure and poor ground contact.</p> <p>If you have a repeated reset, please contact us.</p>
3, 2	☒ ☒ ☒ ☒☒	A reset was performed inside the controller	There is no need to care when the controller is reset due to overcurrent and battery voltage is too high or too low occasionally.
3, 4	☒☒☒  ☒☒☒☒	The pedal would have signal when switching the direction	1.The controller will stop outputting. And it will return to normal after the releasing the pedal.
4, 1	☒ ☒ ☒ ☒ ☒	Overvoltage errors during regenerative electric power or startup.	1.The overvoltage controller would not start the motor if there is overvoltage after power-on. The error controller would reduce the volt or even stop generating if there is overvoltage during the generating. And the overvoltage value could be set on the graphical user interface, up to 1.25 times the rated voltage of the controller. for example, the overvoltage could be set at 60V for a 48V controller.
4, 2	☒☒☒☒  ☒☒	Signal error of Hall sensor	<p>1.This error occurs when the 120 degree Hall motor has 60 degree Hall code, or the 60 degree Hall motor has 120 degree Hall code. The user should correct the type of angle through the software.</p> <p>2.The wiring is incorrect.</p> <p>3.The Hall sensor is damaged or intermittent appearance.</p>
4, 3	☒☒☒☒  ☒☒☒	Motor is overheat	<p>1. When the temperature is higher than the set of the sensor, the motor would stop until it cool down to the recovery temperature.</p> <p>2. The overheat temperature could be changed through the calibration software.</p>





Shandong Chufeng Heavy Industry Machinery Group Co., Ltd

**-Operation and Maintenance Manual**

4, 4	<p>○○○○</p> <p>○○○○</p>	Motor stalling	<p>1. When there is stalling, the controller would limit the maximum output to 90% before the stall occurs. And when the stalling disappears, this error alarm code will disappear automatically. The max output would back to normal.</p>
------	-------------------------	----------------	--

When the red LED flashing, it indicates an error. For example, 1, 2 mean that the LED flashing one and after one second flashing another two times, this means there is an overvoltage error. The time of the on and off for the LED is 0.5 seconds, after one error was displayed, the LED would be off for two seconds and then display another error until the errors were cleared.

**4. Working principle**

Drawing of Hydraulic principle:

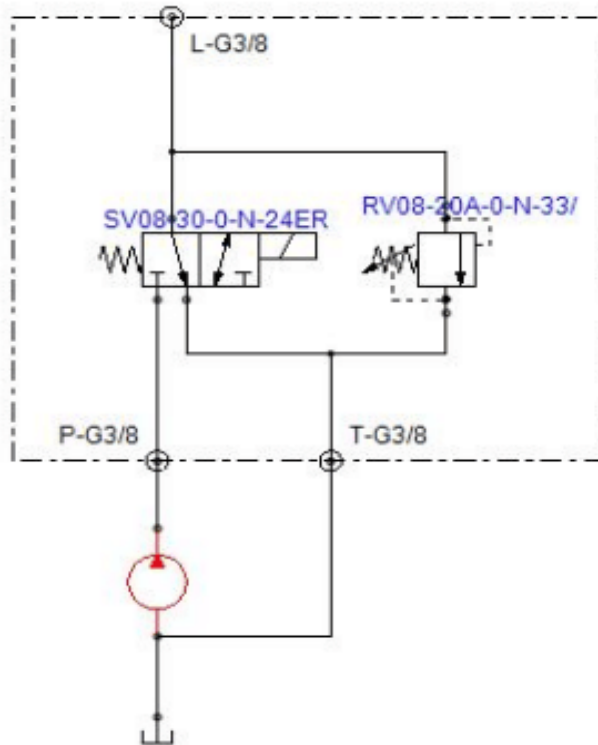

Working pressure is less than 241BAR

Working flow is less than 11L/min



Shandong Chufeng Heavy Industry Machinery Group Co., Ltd

**-Operation and Maintenance Manual**

Drawing of electrical principle:





Shandong Chufeng Heavy Industry Machinery Group Co., Ltd

-Operation and Maintenance Manual

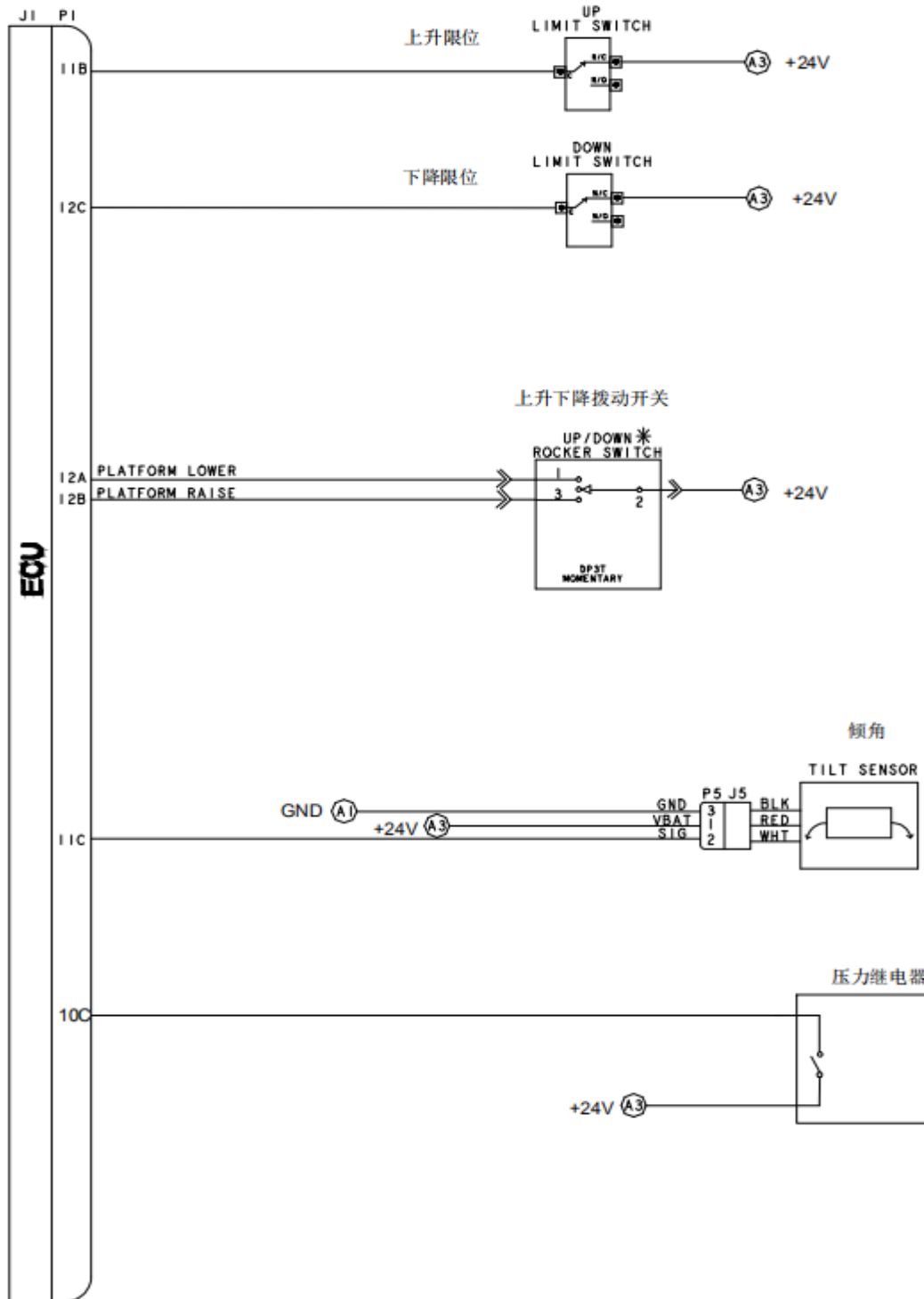



Shandong Chufeng Heavy Industry Machinery Group Co., Ltd

-Operation and Maintenance Manual

## II. Part List of Self-Propelled Scissor Lift

No.	Item	Specification	Position	Unit	Qty
1	φ13-410	M22*1.5 — 90°	Fuel tank outlet to gear pump suction port	Pcs	1
2	φ13-350	M22*1.5	Gear pump outlet to main valve interface P	Pcs	1
3	φ8-4500	M16*1.5	Main valve interface CSE to lower lift cylinder lock valve interface	Pcs	1
4	φ13-365	M22*1.5 — 45°	Main valve interface T3 to oil filter	Pcs	1
5	φ13-420	M22*1.5 — 45°	Oil filter to tank return port	Pcs	1
6	Connector	M22*1.5	Main valve inlet	Pcs	1
7	Connector	M18*1.5/M22*1.5H	Main valve inlet change direction	Pcs	1
8	Connector	M18*1.5/M22*1.5H	Main valve return port	Pcs	1
9	Connector	M18*1.5/M16*1.5H	Main valve lift port	Pcs	1
10	Connector	G3/8/M16×1.5H	Lower cylinder lock valve port joint	Pcs	2
11	Three-way connector	M16X1.5H (	Lower cylinder lock valve port joint	Pcs	1
12	Connector	2001/4/27	Cylinder exhaust port connector	Pcs	1
13	Connector	RC3/4/M22X1.5	Oil filter connector	Pcs	2
14	Connector	M22X1.5/M22X1.5 (90 °)	Fuel tank return port connector	Pcs	1
15	Connector	M27X2/M27X2	Fuel tank connector	Pcs	1



Shandong Chufeng Heavy Industry Machinery Group Co., Ltd

-Operation and Maintenance Manual

16	Connector		Telescopic platform	Set	1
17	Hinge, torsion spring, pin		Platform door	Set	2
18	D-pin		Guardrail	Pcs	4
19	Bearing	6204	Platform wheel	Pcs	4
20	Inner circlip	47	Platform wheel	Pcs	4
21	Nylon roller	φ125	Telescopic platform	Pcs	2
22	Nylon small roller	φ120	Fixed platform	Pcs	2
23	Small slider		Upper platform	Pcs	4
24	Rubber septum		Fixed platform guardrail	Pcs	4
25	bolt		Platform door	Pcs	1
26	Door spring		bolt	Pcs	2
27	Small cotter pin	2	Platform door hinge	Pcs	2
28	Bolt flat spring pad	M10*25	Foot lock	Set	2
29	Bolt	M8*50	Platform door hinge	Set	8
30	Flat pad	M8*60	Folding fence	Set	12
31	Self-locking nuts	M10*50	Door lock	Set	1
32	Countersunk bolt	M8*60	Platform roller mount	Pcs	16
33	Self-tapping screw	M4*30	Rubber septum	Pcs	4
34	Pole pin 1	φ38*660		Pcs	4
35	Strut pin 2	φ38*220		Pcs	4
36	Lower slider pin	φ38*370		Pcs	2



Shandong Chufeng Heavy Industry Machinery Group Co., Ltd

-Operation and Maintenance Manual

37	Upper slider pin	φ38*150		Pcs	2
38	Cylinder pin 3	φ38*160		Pcs	1
39	Strut pin 2	φ38*230		Pcs	2
40	Bracket cushion		Strut	Pcs	32
41	C-type retaining ring		Pole shaft fixed wire frame	Pcs	2
42	U-ring		Safety support	Pcs	2
43	Fiber sleeve	φ44*φ38*50	Strut	Pcs	6
44	Fiber sleeve	φ44*φ38*30	Strut	Pcs	18
45	Lower cylinder	φ80	Scissor assembly	Pcs	1
46	Lower cylinder valve block	ST3720-AC00	Lower cylinder	Pcs	1
47	Soft shaft cable	12K	Lower cylinder lock valve	Pcs	1
48	Bolt Flat pad Self-locking nuts	M10*100	Slider	Set	4
49		M10*75	Fixed strut pin	Set	11
50		M10*40	Cylinder anti-rotation	Set	2
51		M6*20	Cylinder valve block and cable holder	Set	6
52	Countersunk bolt	M6*15	C-type retaining ring	Set	3
53	Hex bolts	M10*40	Scissor support	Set	2
54	Outer circlip	38*2.5	Pole pin	Pcs	5
55	Flat pad	φ38*φ60-4	Pole pin	Pcs	5
56	Anti-reduction	φ10-80	Cylinder pin	Pcs	4
57	Large slider		Outsole scissor	Pcs	2
58	Plastic tee	φ8	Oil return pipe	Pcs	1





Shandong Chufeng Heavy Industry Machinery Group Co., Ltd

**-Operation and Maintenance Manual**

59	Motor	4.5Kw	Pump station box	Pcs	1
60	tank	25L	Pump station box	Pcs	1
61	Pipeline filter	SP-06/08X25	Pump station box	Pcs	1
62	Gear pump	45cc/r	Pump station box	Pcs	1
63	battery		battery box	Pcs	8
64	charger	35A/48V	battery box	Pcs	1
65	switch		battery box	Pcs	1
66	Big insurance	400A	battery box	Pcs	1
67	horn	DL225	battery box	Pcs	1
68	buzzer	BJ-1I	battery box	Pcs	1
69	Battery cap	red + black	battery box	Pcs	24
70	Key switch	3/set	Ground control panel	Set	1
71	Emergency stop switch	1/set	Ground control panel	Set	1
72	Toggle switch	1/set	Ground control panel	Set	1
73	Self-resetting insurance	7A	Ground control panel	Pcs	1
74	Relay		Ground control panel	Pcs	1
75	Emergency stop		Ground control panel	Pcs	1
76	Lower control panel		Chassis	Pcs	1
77	LED small light		Ground control panel	Pcs	1
78	Limit switch		Flap	Set	4
79	Waterproof connector		Limit switch	Pcs	4



Shandong Chufeng Heavy Industry Machinery Group Co., Ltd

-Operation and Maintenance Manual

80	Strobe light		Chassis	Pcs	1
81	Door lock		Electric control box	Pcs	1
82	Drawer slide		Electric control box	Pcs	2
83	Optocoupler converter		Electric control box	Pcs	1
84	DC converter	DC48-DC24	Electric control box	Pcs	1
85	motor driver		Rear of the chassis	Pcs	2
86	Drag chain	1.5m	battery box	Pcs	1
87	Travel limit block		Limit switch	Pcs	1
88	Round head Phillips screw	M6*15	Lower control panel	Set	2
89	Hexagon socket bolt	M5*15	Limit switch cover	Set	4
90	Hexagon socket bolt	M8*25	Motor installation	Set	4
91	Round head Phillips screw	M4*20	ECU	Set	4
92	Hexagon socket bolt	M6*20	Pipeline filter	Set	4
93	Semi-round head bolt	M4*15	charging port	Set	2
94	Semi-round head bolt	M6*15	switch	Set	2
95	Countersunk head hex bolt	M8*25	tank	Set	4
96	Countersunk head hex bolt	M8*25	Motor base	Set	4



Shandong Chufeng Heavy Industry Machinery Group Co., Ltd

-Operation and Maintenance Manual

97	Hexagon socket bolt	M6*15	horn	Set	2
98	Hexagon socket bolt	M6*15	Big insurance	Set	2
99	Hexagon socket bolt	M6*10	buzzer	Set	2
100	Hexagon socket bolt	M8*20	Valve block	Pcs	2
101	Semicircular head cross bolt	M5*10	Optocoupler converter	Pcs	2
102	Hexagon socket bolt	M6*20	charger	Set	2
103	Hexagon socket bolt	M6*15	motor driver	Set	8
104	Hexagon flange bolt	M6*15	Door lock	Set	5
105		M12*40	Back ladder	Set	2
106		M6*20	Oil filter	Pcs	2
107	Control System		Harness. Dip. Control. ECU.	Set	1